

WITH ATTACHMENT

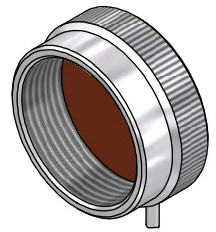

ATTACHMENT OPTIONS:

-01 TO -05
EYELET
OPTION
(TABLE 2)

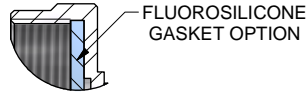
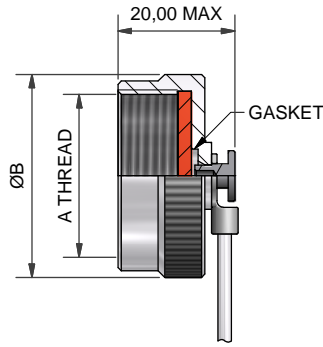
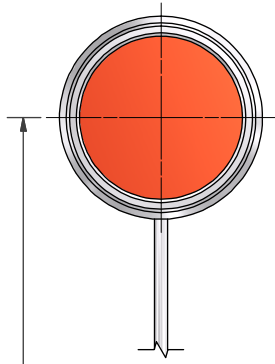
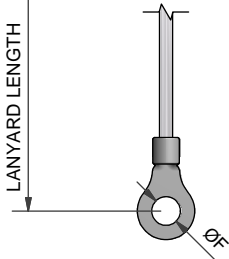

-10 TO -36
RING OPTION
(FITS OVER JAM NUT THREAD)
(TABLE 3)

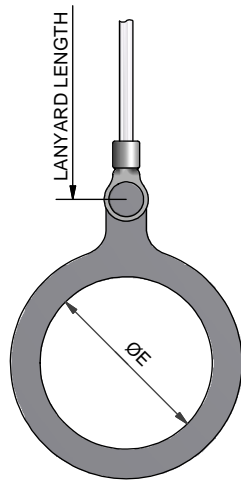

-CF
CRIMP
FERRULE
OPTION

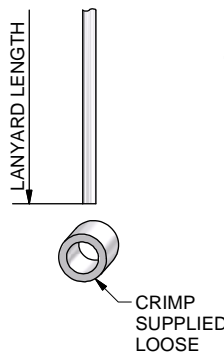

-00
NO
TERMINATION



-TR
TIE-WRAP
OPTION

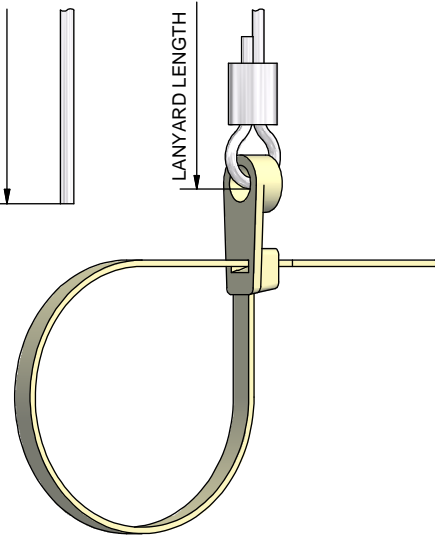

OMIT FOR NO ATTACHMENT
(SEE SHEET 2)

100P1240-16-1-C-WR4-16

SERIES
 INSERT 'F' FOR FLUOROSILICONE GASKET
 OMIT FOR STANDARD SILICONE GASKET
 SHELL SIZE (TABLE 1)
 MATERIAL (TABLE 5)
 FINISH (TABLE 6)
 LANYARD TYPE (TABLE 4)
 LANYARD LENGTH (IN INCHES)
 +1,0"/-0" TOLERANCE
 ATTACHEMENT (SEE ABOVE)

| | | | |
|------------------|---------|--------|------------|
| DRAWN | J.CLARK | DATE | 03/12/2008 |
| SALES APPR | | DATE | 03/12/2008 |
| DESIGN APPR | | | |
| PROD APPR | | | |
| QUAL APPR | | | |
| ISSUE | DCR | | |
| 2 | 3969 | | |
| NCAGE CODE U5792 | | WEIGHT | |

| | |
|--|-----------------------------------|
| | 3RD ANGLE PROJECTION NOT TO SCALE |
| UNLESS OTHERWISE SPECIFIED ALL DIMENSIONS IN MILLIMETRES | |
| GENERAL TOL LINEAR +/-0.25MM ANGULAR +/- 1° | |
| MATERIAL SEE TABLE 5 | |
| FINISH SEE TABLE 6 | |

| | | |
|---------------------------------------|---------------------------------------|---|
| | POLAMCO LTD www.polamco.com | WESTON LOCK LOWER BRISTOL ROAD BATH BA2 1EP |
| ASSY USED ON: MIL-DTL-5015 | | |
| TITLE: RECEPTACLE PROTECTION COVER | | |
| PART NUMBER: 100P1240 SERIES | | |

| | |
|--|-----|
| THIS DRAWING IS COPYRIGHT AND THE PROPERTY OF POLAMCO LTD | |
| IT MUST NOT BE COPIED, USED FOR MANUFACTURE OR OTHERWISE DISCLOSED WITHOUT PRIOR WRITTEN CONSENT OF THE COMPANY. | |
| DRAWING NO: | SHT |
| P12091 | 1 |

TABLE 1

| SHELL SIZE | A THREAD | ØB MAX |
|------------|---------------|--------|
| 10SL | 5/8-24 UNEF | 24,2 |
| 12S | 3/4-20 UNEF | 24,2 |
| 14S | 7/8-20 UNEF | 26,6 |
| 16S | 1-20 UNEF | 30,4 |
| 16 | 1-20 UNEF | 30,4 |
| 18 | 1 1/8-18 UNEF | 32,5 |
| 20 | 1 1/4-18 UNEF | 35,7 |
| 22 | 1 3/8-18 UNEF | 38,9 |
| 24 | 1 1/2-18 UNEF | 42,1 |
| 28 | 1 3/4-18 UNS | 48,5 |
| 32 | 2-18 UNS | 54,8 |
| 36 | 2 1/4-16UN | 60,2 |

TABLE 2

| EYELET REF. | ØF |
|-------------|-----|
| 01 | 3,2 |
| 02 | 3,7 |
| 03 | 4,3 |
| 04 | 5,3 |
| 05 | 6,4 |

TABLE 3

| RING REF. | ØE |
|-----------|------|
| 10 | 16,1 |
| 12 | 19,4 |
| 14 | 22,6 |
| 16 | 25,8 |
| 18 | 28,8 |
| 20 | 32,0 |
| 22 | 35,0 |
| 24 | 38,3 |
| 28 | 44,6 |
| 32 | 51,2 |
| 36 | 57,5 |

TABLE 4

| CODE | LANYARD TYPE |
|------|---|
| WR | NYLON COVERED (CLEAR) STAINLESS STEEL WIRE ROPE |
| TC | TEFLON COVERED (CLEAR) STAINLESS STEEL WIRE ROPE |
| WG | TEFLON COVERED (OLIVE DRAB) STAINLESS STEEL WIRE ROPE |
| WB | TEFLON COVERED (BLACK) STAINLESS STEEL WIRE ROPE |
| WRB | PVC COVERED (BLACK) STAINLESS STEEL WIRE ROPE |
| LC | LINK CHAIN |
| BK | BLACK CORD |
| VGB | 1,5mm BLACK POLYESTER CORD EQV. TO DIN83330-E1,5 |
| B | BEAD CHAIN |
| R | OLIVE DRAB POLYESTER CORD |
| NB | OLIVE DRAB NYLON CORD |
| NK | BLACK NYLON CORD |

TABLE 5

| CODE | MATERIAL |
|------|-------------------------|
| 1 | ALUMINIUM |
| 2 | NICKEL ALUMINIUM BRONZE |
| 4 | STAINLESS STEEL |
| 7 | BLACK ACETAL |
| 74 | COMPOSITE |

LIST NOT EXHAUSTIVE, SEE MATERIAL TABLE FOR OTHER OPTIONS

TABLE 6

| CODE | DESCRIPTION |
|------|---|
| B | CADMIUM, OLIVE DRAB OVER ELECTROLESS NICKEL |
| C | ELECTROLESS NICKEL |
| G | BLACK ANODISE, SULPHURIC |
| J | PASSIVATE |
| U | UNPLATED CLEAN FINISH NOT SHOT BLASTED |
| Z | SHOT BLAST FOR NON-REFLECTIVE FINISH |
| ZB | ZINC COBALT OLIVE DRAB OVER ELECTROLESS NICKEL |
| ZN | ZINC NICKEL BLACK PASSIVATE OVER ELECTROLESS NICKEL |

LIST NOT EXHAUSTIVE, SEE PLATING TABLE FOR OTHER OPTIONS

WITHOUT ATTACHMENT

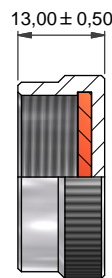

100P1240-16-1-C
NO ATTACHMENT VERSION

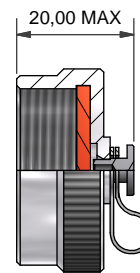

100P1240-16-1-C-EO
EYELET ONLY VERSION
(NO LANYARD)

| | | | | | | | |
|--------------------|---------|--------|------------|---|--|---|--|
| DRAWN | J.CLARK | DATE | 03/12/2008 | 3RD ANGLE PROJECTION NOT TO SCALE | POLAMCO LTD www.polamco.com | WESTON LOCK LOWER BRISTOL ROAD BATH BA2 1EP | THIS DRAWING IS COPYRIGHT AND THE PROPERTY OF POLAMCO LTD IT MUST NOT BE COPIED, USED FOR MANUFACTURE OR OTHERWISE DISCLOSED WITHOUT PRIOR WRITTEN CONSENT OF THE COMPANY. |
| SALES APPR | | DATE | 03/12/2008 | | | | |
| DESIGN APPR | | | | UNLESS OTHERWISE SPECIFIED ALL DIMENSIONS IN MILLIMETRES GENERAL TOL LINEAR +/-0.25MM ANGULAR +/- 1° | ASSY USED ON: MIL-DTL-5015 | TITLE: RECEPTACLE PROTECTION COVER | DRAWING NO: SHT P12091 2 |
| PROD APPR | | | | | | | |
| QUAL APPR | | | | MATERIAL SEE TABLE 5 | TITLE: RECEPTACLE PROTECTION COVER | PART NUMBER: 100P1240 SERIES | DRAWING NO: SHT P12091 2 |
| ISSUE | DCR | | | | | | |
| 2 | 3969 | | | FINISH SEE TABLE 6 | PART NUMBER: 100P1240 SERIES | DRAWING NO: SHT P12091 2 | DRAWING NO: SHT P12091 2 |
| NCAGE CODE U5792 | | WEIGHT | | | | | |